

# Dynamics in Aerospace

**Airships**

**Aircrafts**

**Spacecrafts**

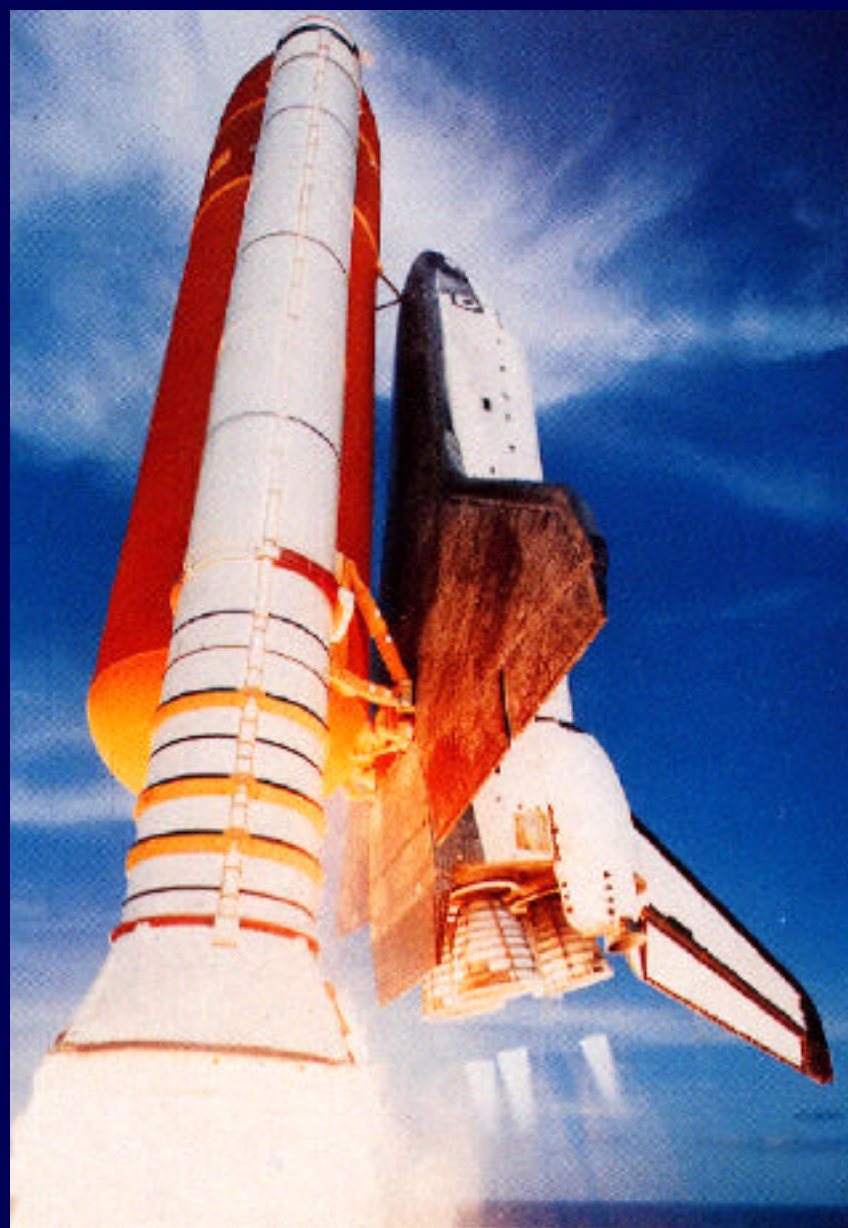



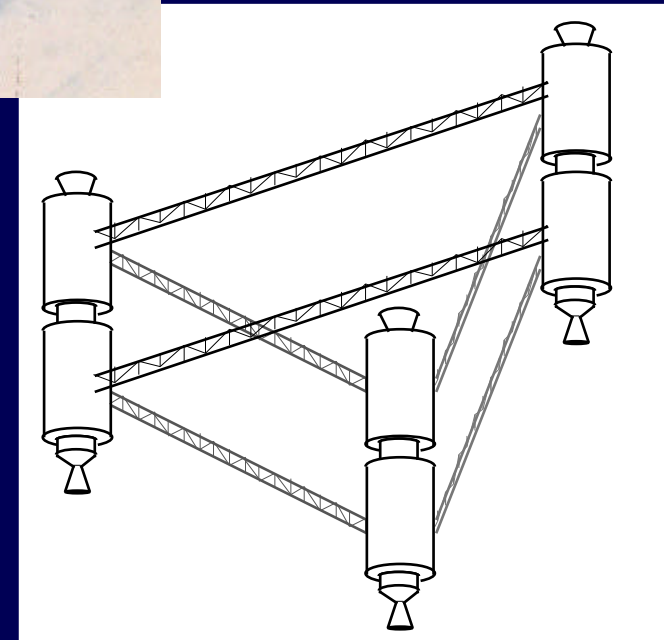
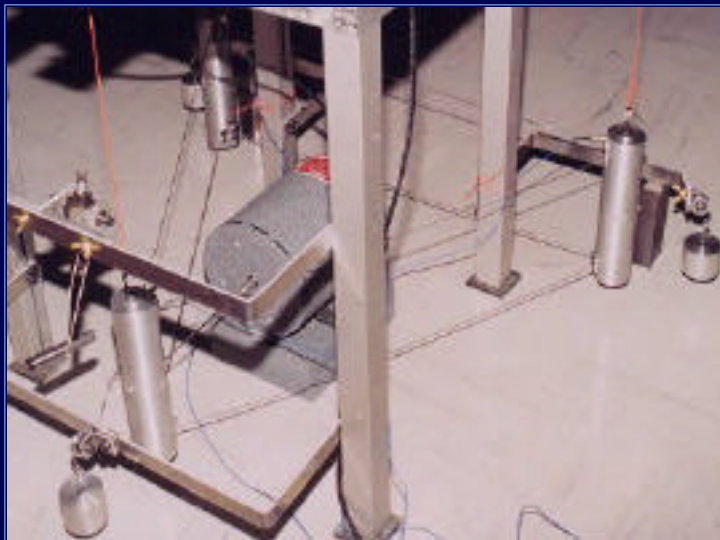
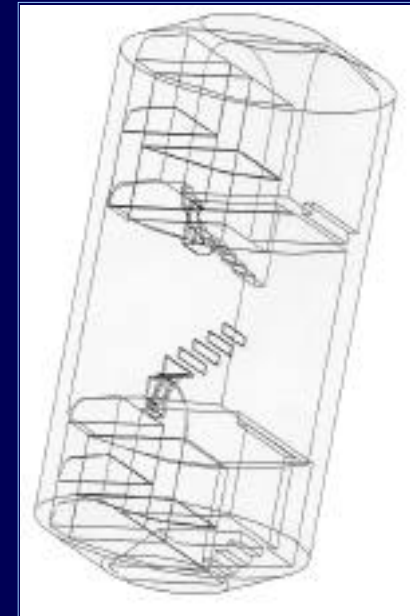

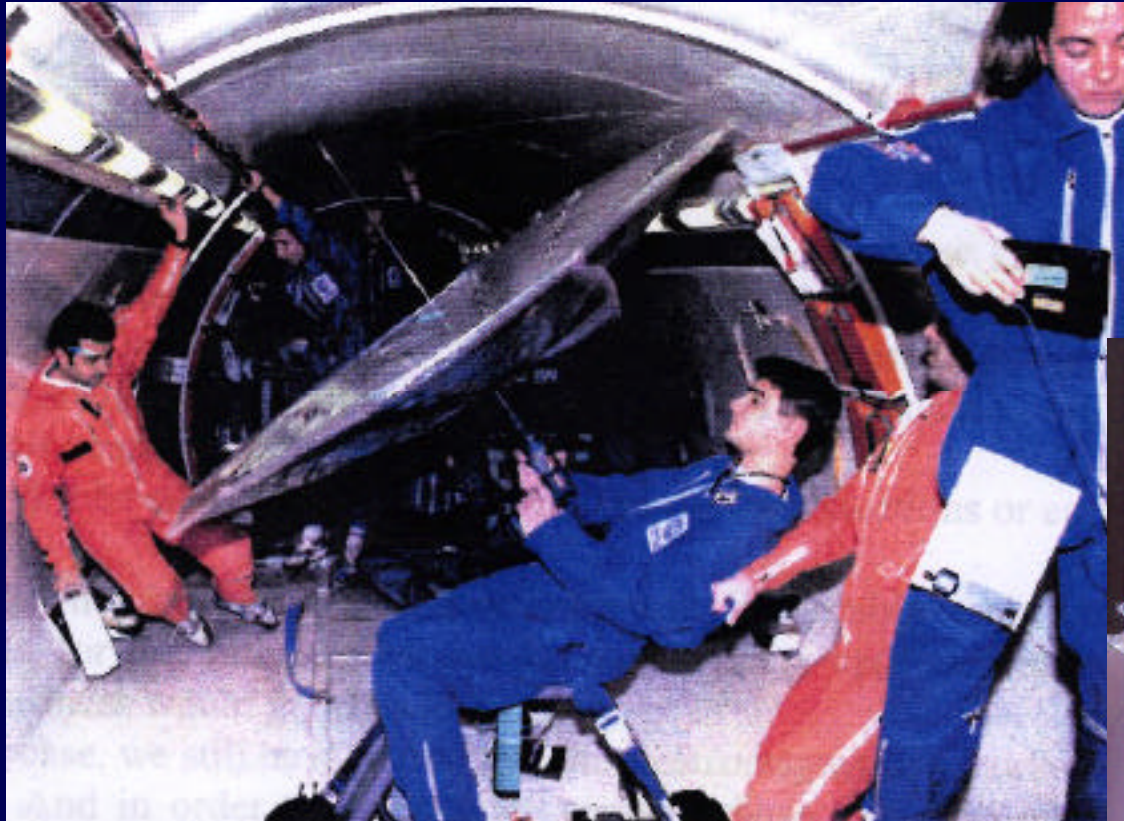

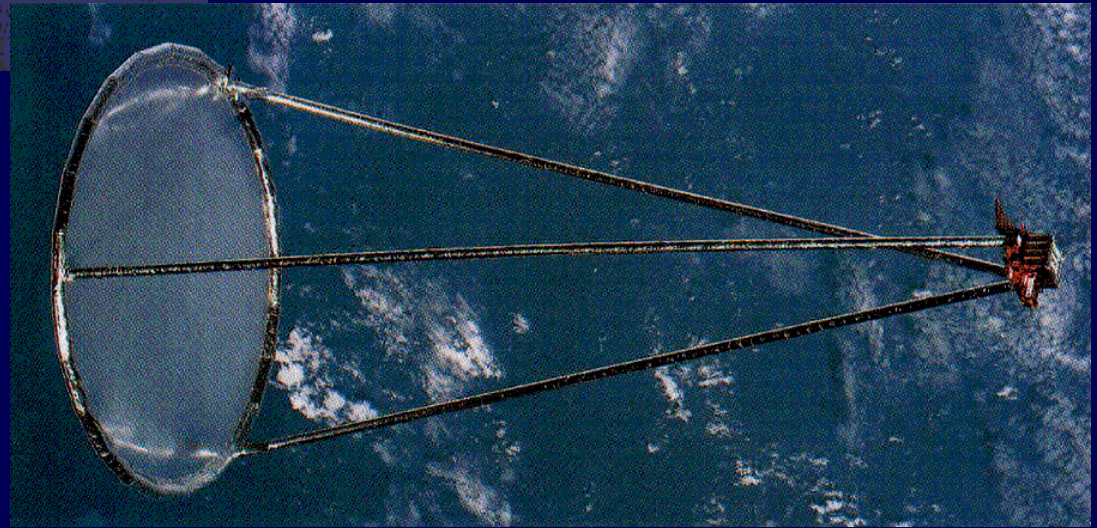
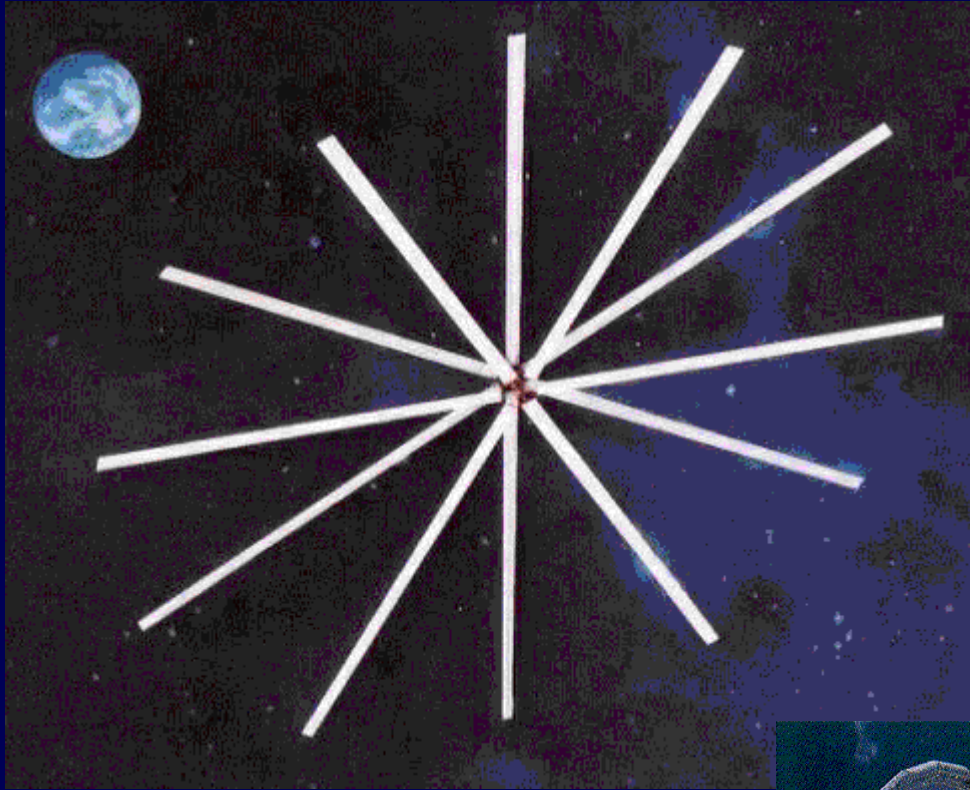

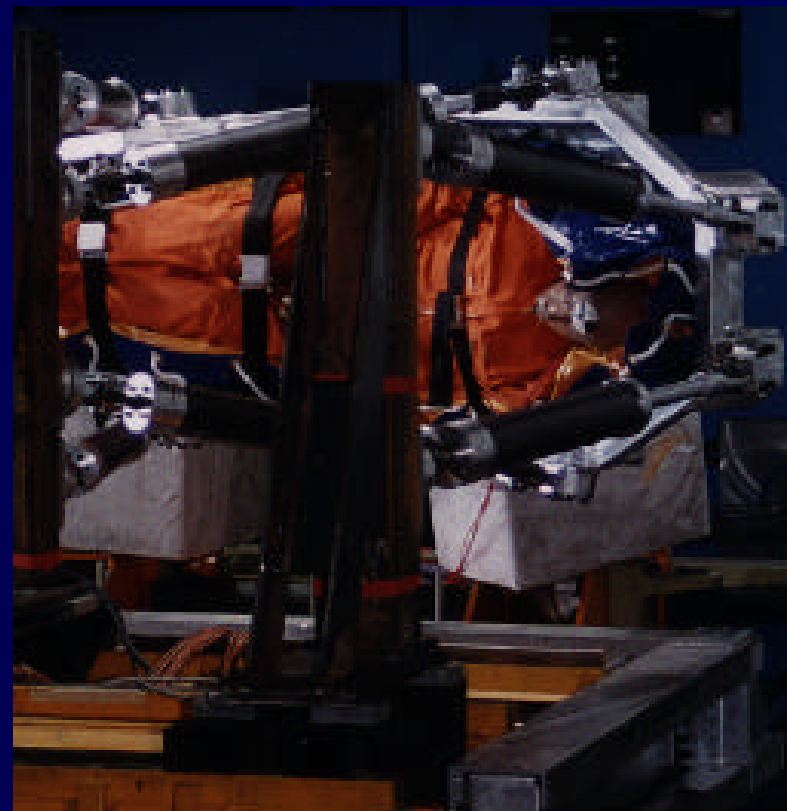
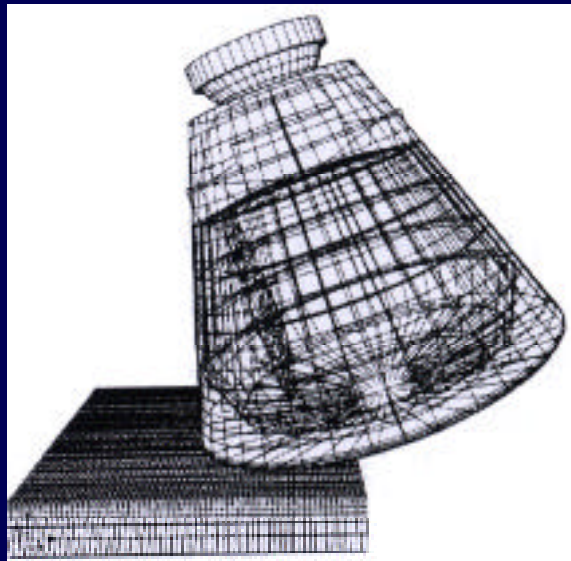
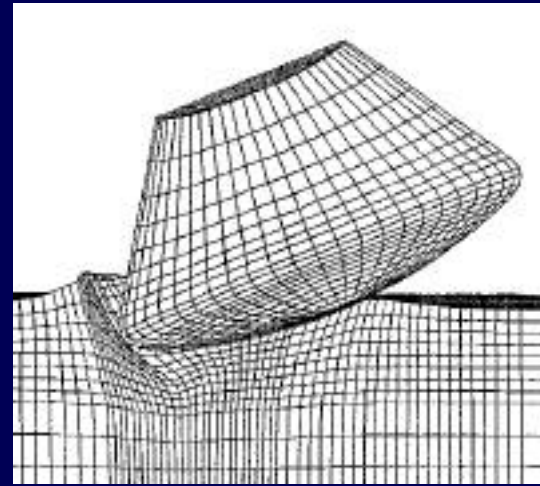





**4 centuries  
same technologies**



# CONCLUSION

**F - Ma = 0 : A Brand New Old Concept**  
**Static sizing to Dynamic Concept :**  
**A certitude, Performance & Safety**  
**for Aerospace !**

